

Open Loop Hall Effect Current Sensor CYHCT-E4

This Hall Effect current sensor is based on open loop principle and can be used for measurement of DC currents. The output of the transducer reflects the real wave of the current carrying conductor.

Product Characteristics	Applications
<ul style="list-style-type: none"> • Excellent accuracy • Very good linearity • Small size • Light in weight • Less power consumption • Window structure • Electrically isolating the output of the transducer from the current carrying conductor • No insertion loss • Current overload capability 	<ul style="list-style-type: none"> • Frequency conversion timing equipments • Various power supply • Uninterruptible power supplies (UPS) • Electric welding machines • Transformer substation • Numerical controlled machine tools • Electrolyzing and electroplating equipments • Electric powered locomotive • Microcomputer monitoring • Electric power network monitoring

ELECTRICAL DATA

Part number	Measuring range	Linearity range	Overload capacity
CYHCT-E4-50A-XY	50A	75A	1000A
CYHCT-E4-100A-XY	100A	150A	2000A
CYHCT-E4-200A-XY	200A	300A	4000A
CYHCT-E4-300A-XY	300A	450A	6000A
CYHCT-E4-400A-XY	400A	600A	8000A
CYHCT-E4-500A-XY	500A	750A	10000A
CYHCT-E4-600A-XY	600A	900A	12000A

Nominal output voltage	Y=1 for 0-4V, Y=2 for 0-5V	V
Supply voltage	X=1 for $\pm 12V \pm 5\%$, X=2 for $\pm 15V \pm 5\%$	V
Current consumption	≤ 25	mA
Galvanic isolation	3KV RMS/50Hz/min	KV

ACCURACY DYNAMIC PERFORMANCE

Zero offset voltage	± 20	mV
Hysteresis error	± 10	mV
Thermal drift of offset current	≤ 250	ppm/ $^{\circ}C$
Response time	≤ 10	μs
Accuracy	± 1.0	%
Linearity	≤ 1.0	%FS

GENERAL DATA

Operating temperature	-10 ~ +80	°C
Storage temperature	-25 ~ +85	°C

DIMENSIONS (mm)

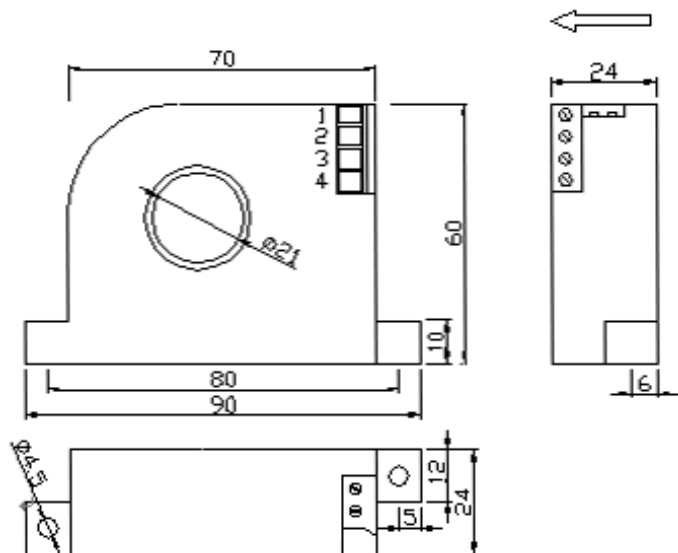

CONNECTION

The current carrying cable must pass through the window. The phase of output is the same as that of the current passing the window in the direction of the arrow indicated on the case.

Wiring of Terminals:

1. +15V/+12V Power Supply
2. -15V/-12V Power Supply
3. +Output
4. Ground

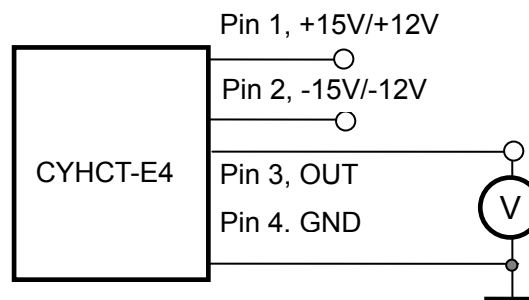

Notes:

1. Connect the terminals of power source, outputs respectively and correctly, never make wrong connection.
2. Two potentiometers can be adjusted, only if necessary, by turning slowly to the required accuracy with a small screwdriver.
3. The best accuracy can be achieved when the window is fully filled with bus-bar (current carrying conductor).
4. The in-phase output can be obtained when the direction of current of current carrying conductor is the same as the direction of arrow marked on the transducer case.