

## Open Loop Hall Effect Current Sensor CYHCT-C8

This Hall Effect current sensor is based on open loop principle and can be used for measurement of DC currents. The output of the transducer reflects the real wave of the current carrying conductor. The sensors use split cores and are easily to mount.

Product Characteristics	Applications
<ul style="list-style-type: none"><li>• Excellent accuracy</li><li>• Very good linearity</li><li>• Using split cores and easy mounting</li><li>• Light in weight</li><li>• Less power consumption</li><li>• Window structure</li><li>• Electrically isolating the output of the transducer from the current carrying conductor</li><li>• No insertion loss</li><li>• Current overload capability</li></ul>	<ul style="list-style-type: none"><li>• Frequency conversion timing equipments</li><li>• Various power supply</li><li>• Uninterruptible power supplies (UPS)</li><li>• Electric welding machines</li><li>• Transformer substation</li><li>• Numerical controlled machine tools</li><li>• Electrolyzing and electroplating equipments</li><li>• Electric powered locomotive</li><li>• Microcomputer monitoring</li><li>• Electric power network monitoring</li></ul>

### ELECTRICAL DATA

Part number	Measuring range	Linearity range	Overload capacity
CYHCT-C8-100A-XY	100A	150A	2kA
CYHCT-C8-200A-XY	200A	300A	4kA
CYHCT-C8-300A-XY	300A	450A	6kA
CYHCT-C8-400A-XY	400A	600A	8kA
CYHCT-C8-500A-XY	500A	750A	10kA

Nominal output voltage	Y=1 for 0-4V, Y=2 for 0-5V	V
Supply voltage	X=1 for $\pm 12V \pm 5\%$ , X=2 for $\pm 15V \pm 5\%$	V
Current consumption	$\leq 25$	mA
Galvanic isolation	3KV RMS/50Hz/min	KV

### ACCURACY DYNAMIC PERFORMANCE

Zero offset voltage	$\pm 20$	mV
Hysteresis error	$\pm 10$	mV
Thermal drift of offset current	$\leq 500$	ppm/ $^{\circ}C$
Response time	$\leq 10$	$\mu s$
Accuracy	$\pm 1.0$	%
Linearity	$\leq 1.0$	%FS

# BB AUTOMACAO

## GENERAL DATA

Operating temperature	-10 ~ +80	°C
Storage temperature	-25 ~ +85	°C

## DIMENSIONS (mm)

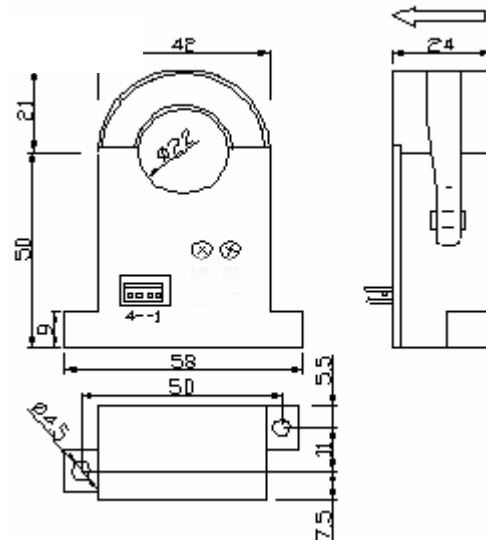

## CONNECTION

The current carrying cable must pass through the window. The phase of output is the same as that of the current passing the window in the direction of the arrow indicated on the case.

### Wiring of Terminals:

1. +15V/+12V Power Supply
2. -15V/-12V Power Supply
3. Output
4. Ground

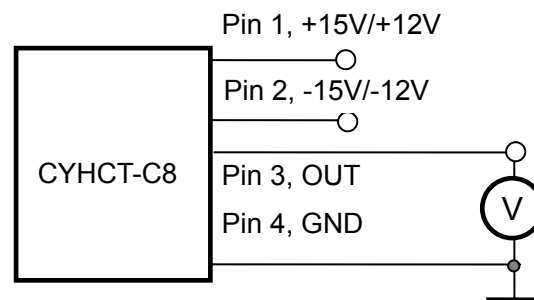

### Notes:

1. Connect the terminals of power source, outputs respectively and correctly, never make wrong connection.
2. Two potentiometers can be adjusted, only if necessary, by turning slowly to the required accuracy with a small screwdriver.
3. The best accuracy can be achieved when the window is fully filled with bus-bar (current carrying conductor).
4. The in-phase output can be obtained when the direction of current of current carrying conductor is the same as the direction of arrow marked on the transducer case.